

Pass Transistor

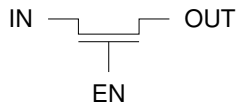

CMOS Transmission Gate

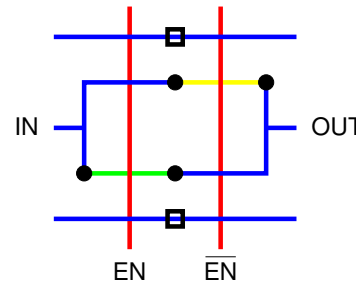
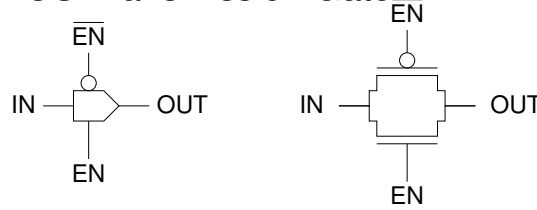

Transmission Gate Multiplexor

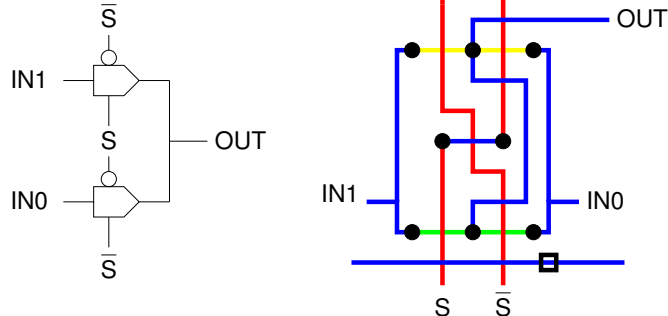
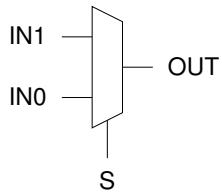

*note distinctive polysilicon crossover

Tri-state gates are used for Multiplexing

Distributed Multiplexing

using transmission gates

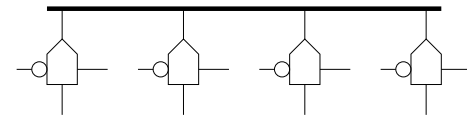

using tri-state inverters

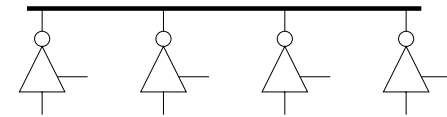

using tri-state buffers

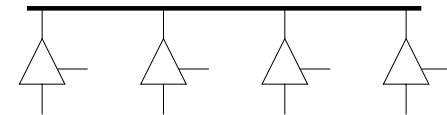

Tri-state Inverter

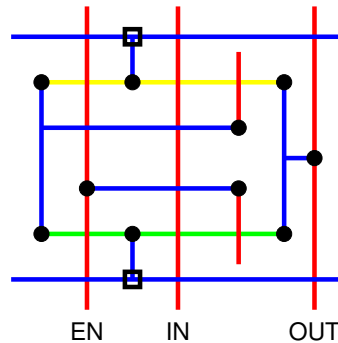
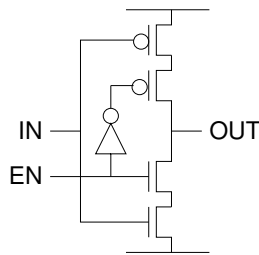
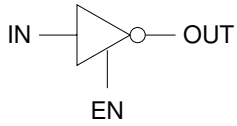

Tri-state Buffer

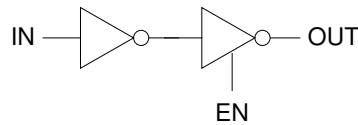
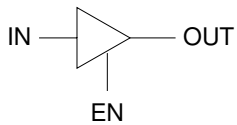

Bi-directional I/O

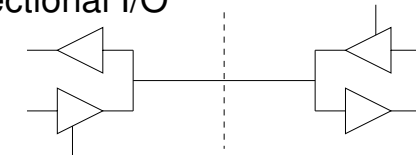

*this is another form of multiplexing