

Transmission Gate Multiplexor

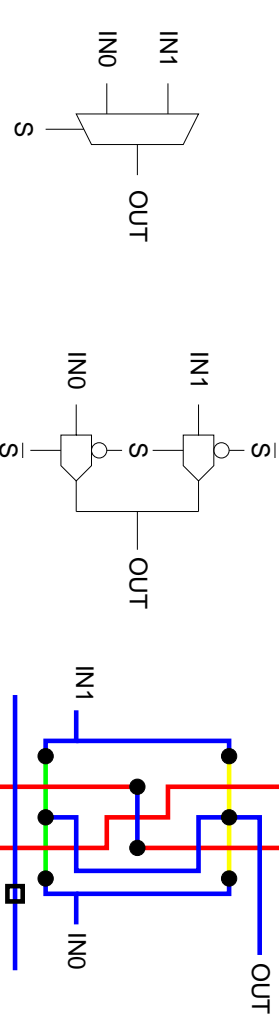

*note distinctive polysilicon crossover

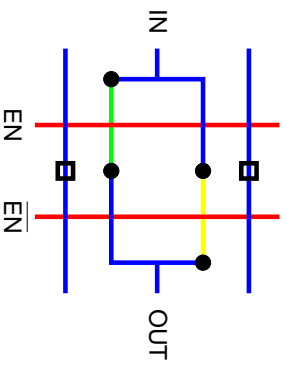

Tri-state gates are used for Multiplexing

Tri-state Inverter

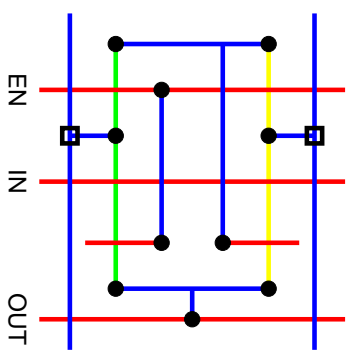
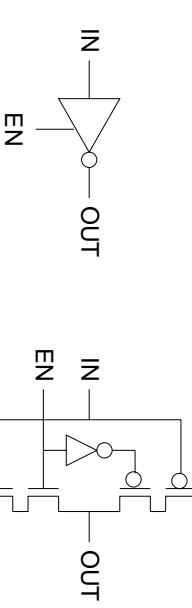

Tri-state Buffer

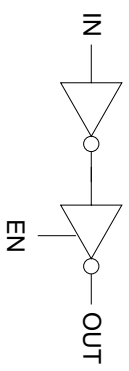
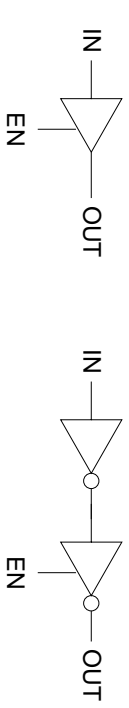

Distributed Multiplexing

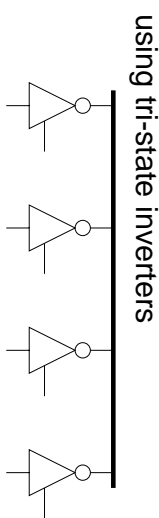
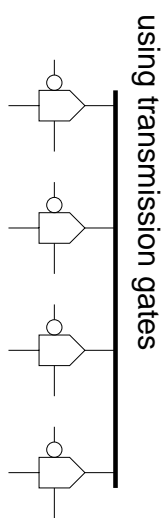

using tri-state buffers

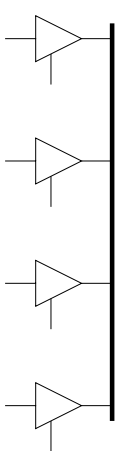

Bi-directional I/O

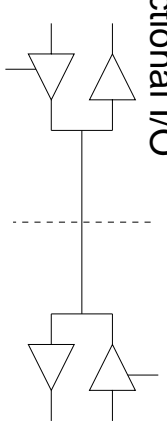

*this is another form of multiplexing